

# Clarion Collection Hotel Helma

20.03.2019

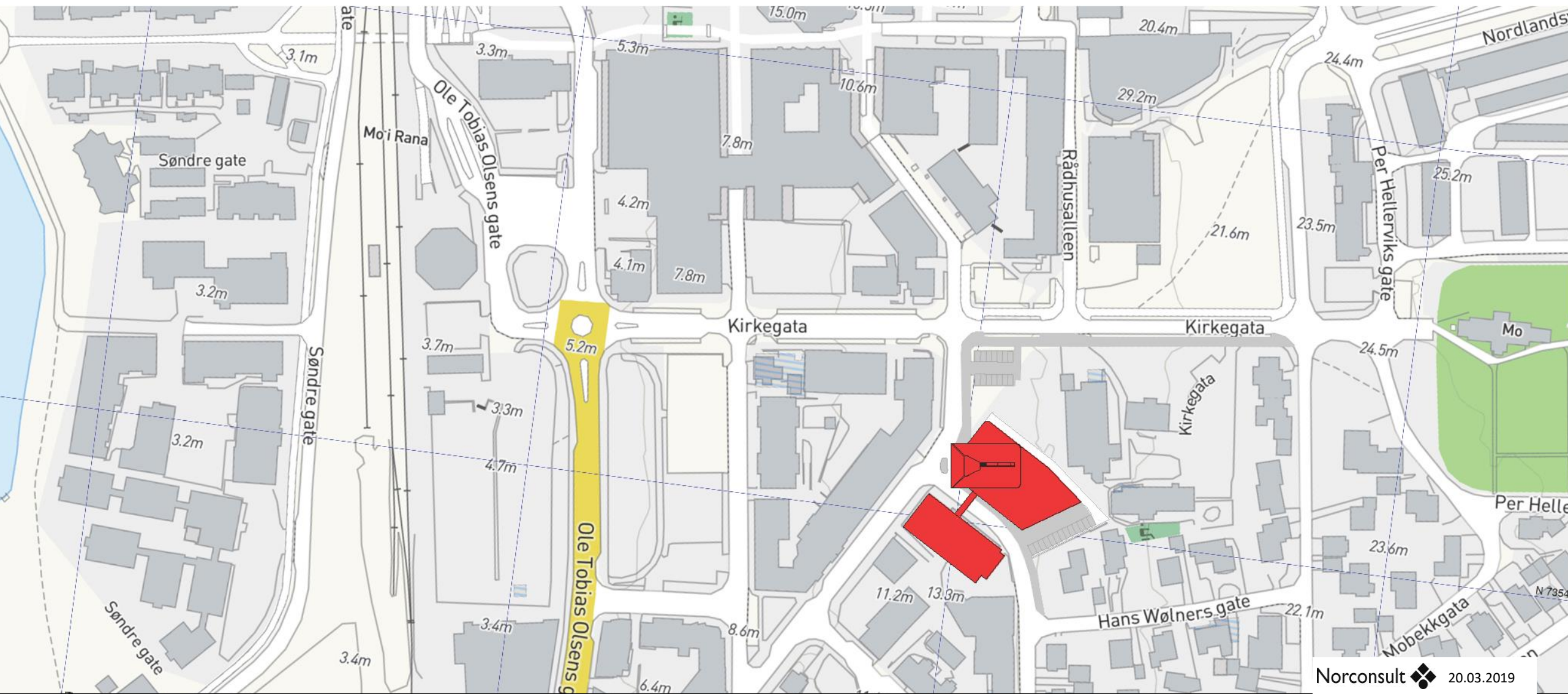

situation

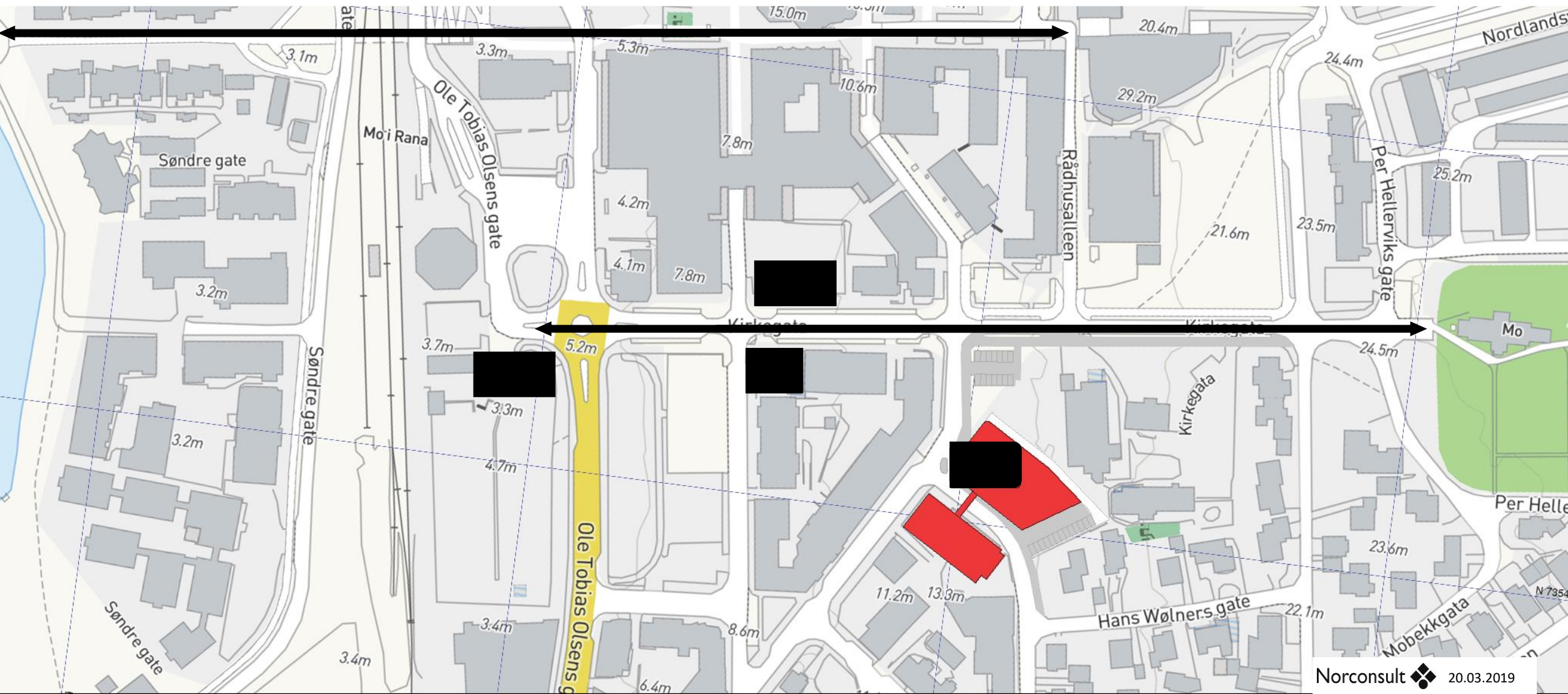

situation and important grid



ground floor

bta  
new: 1400m<sup>2</sup>

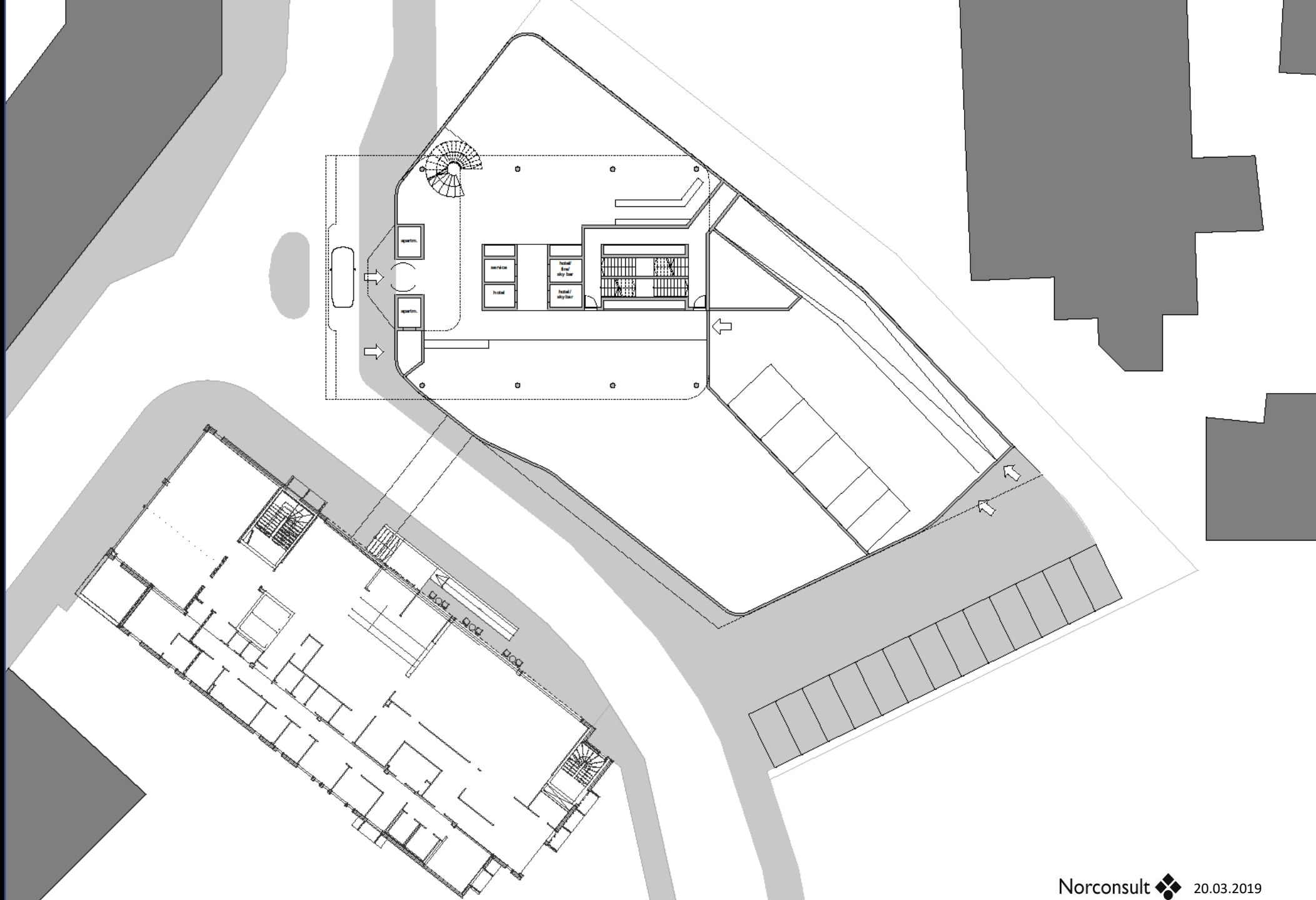

old and new



entrances

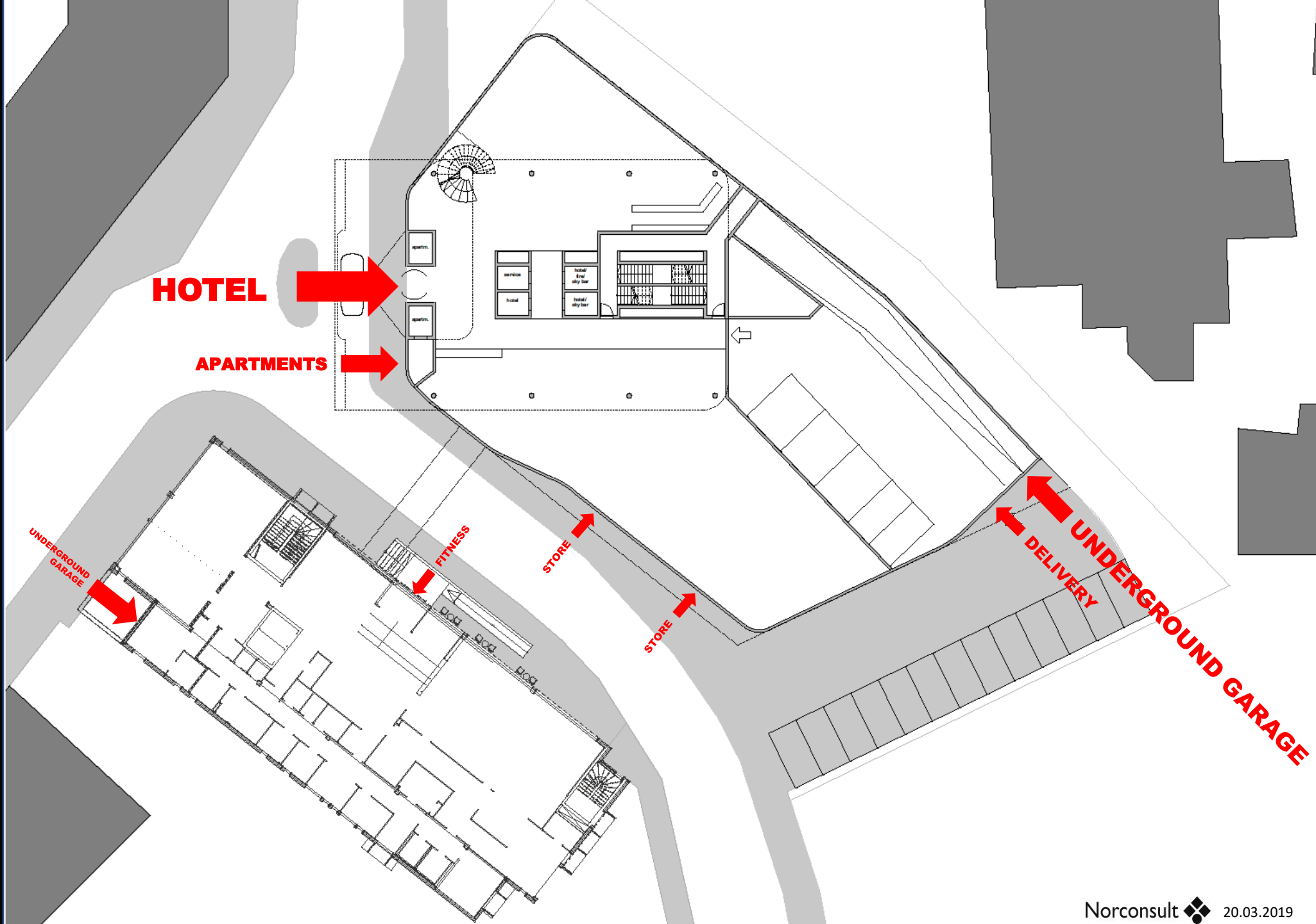

functions



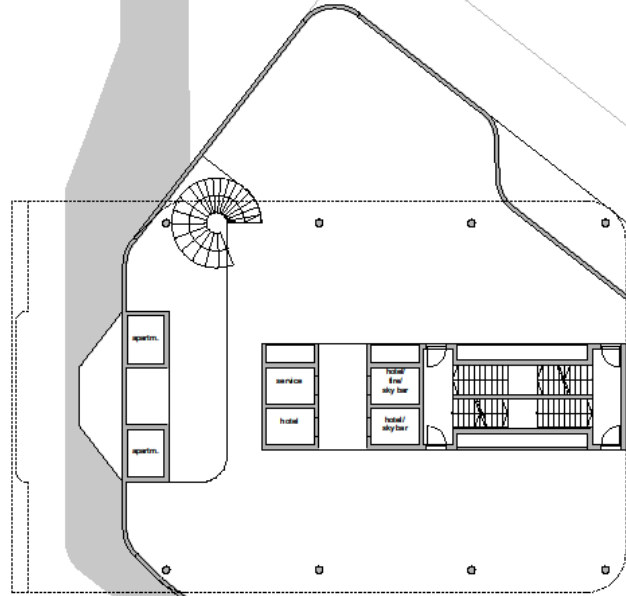

first floor

bta  
new:1470m2





functions

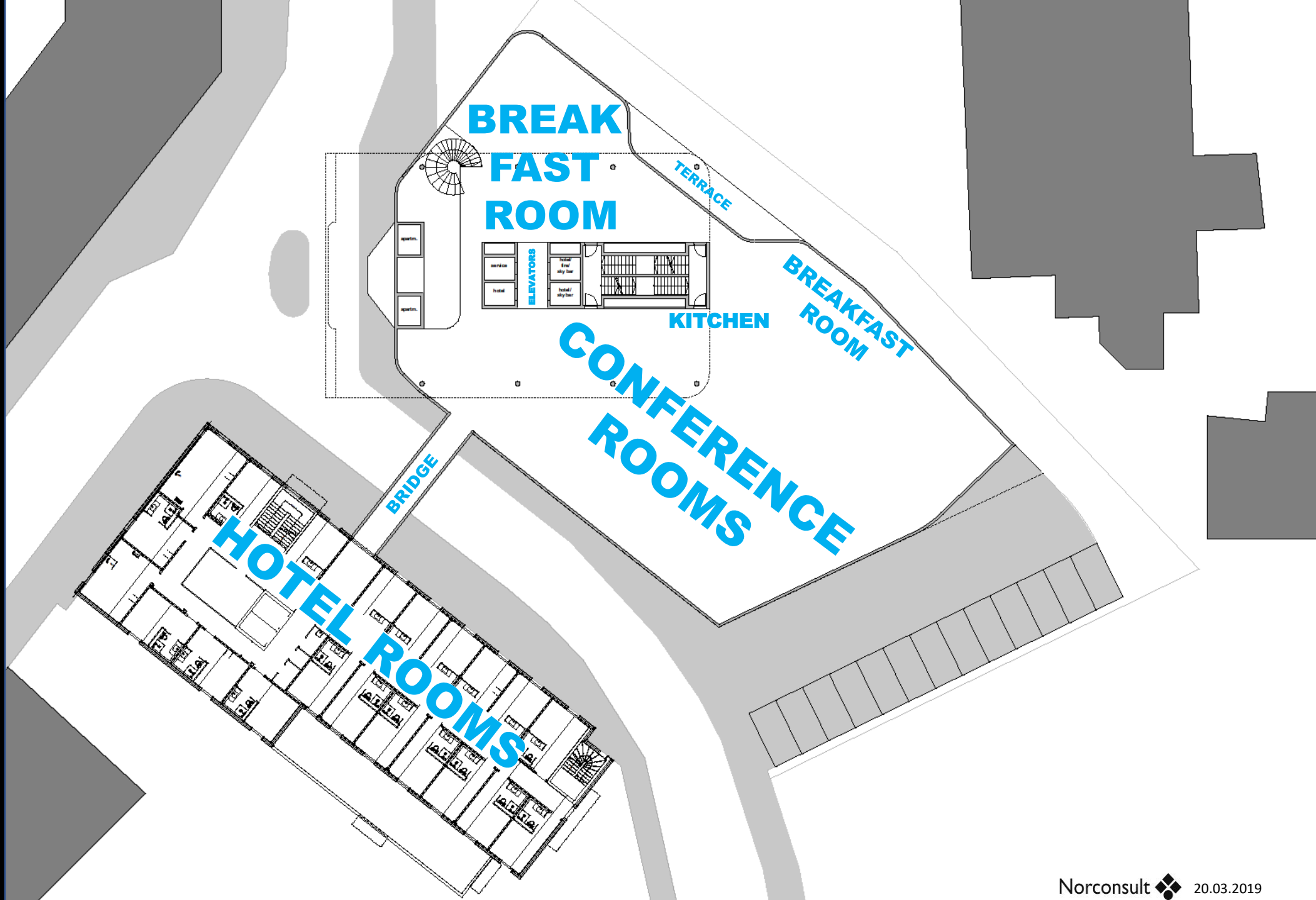

10 floors with  
each 12 new  
hotel rooms

bta new:  
10 x 530m<sup>2</sup>

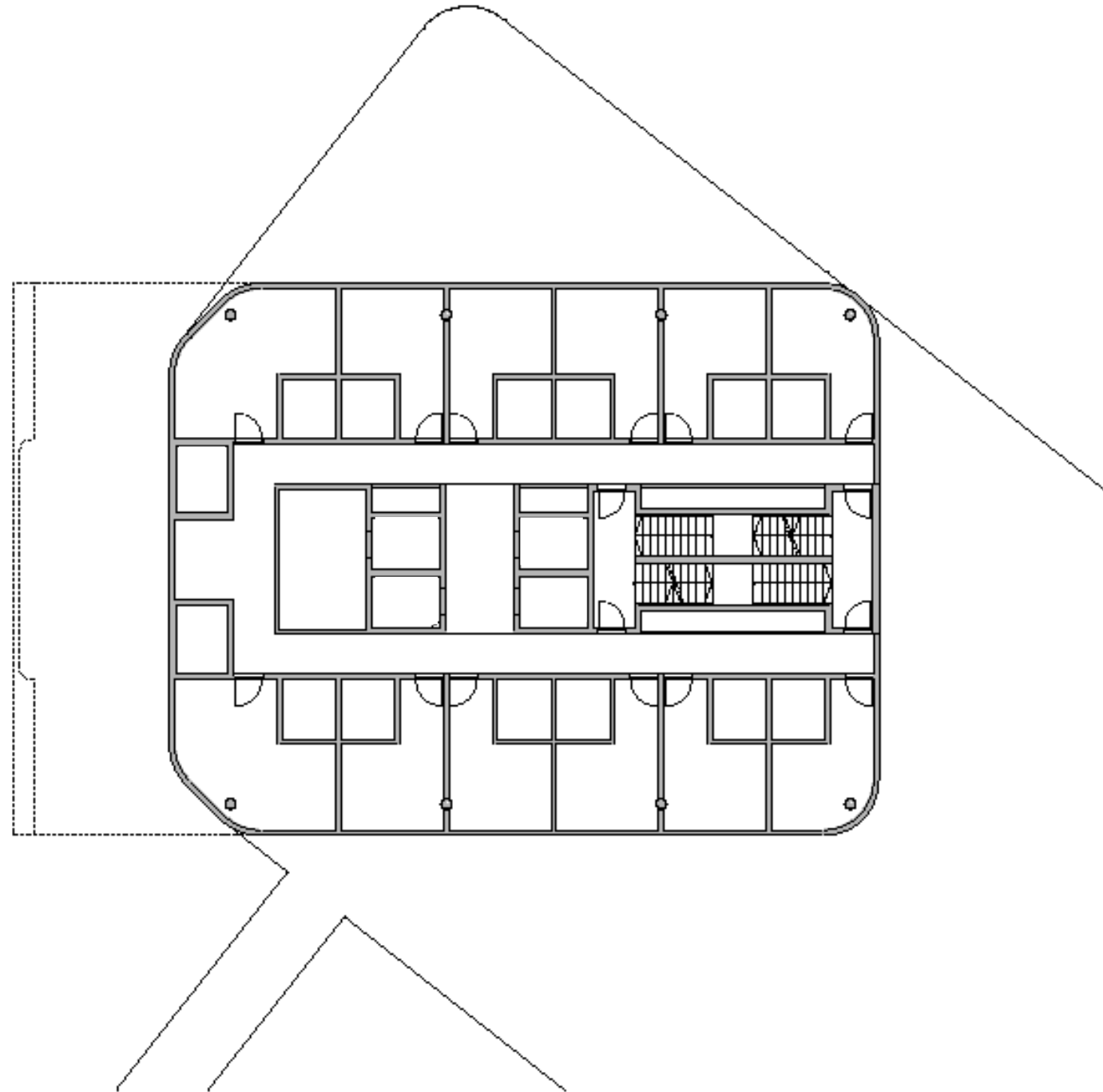

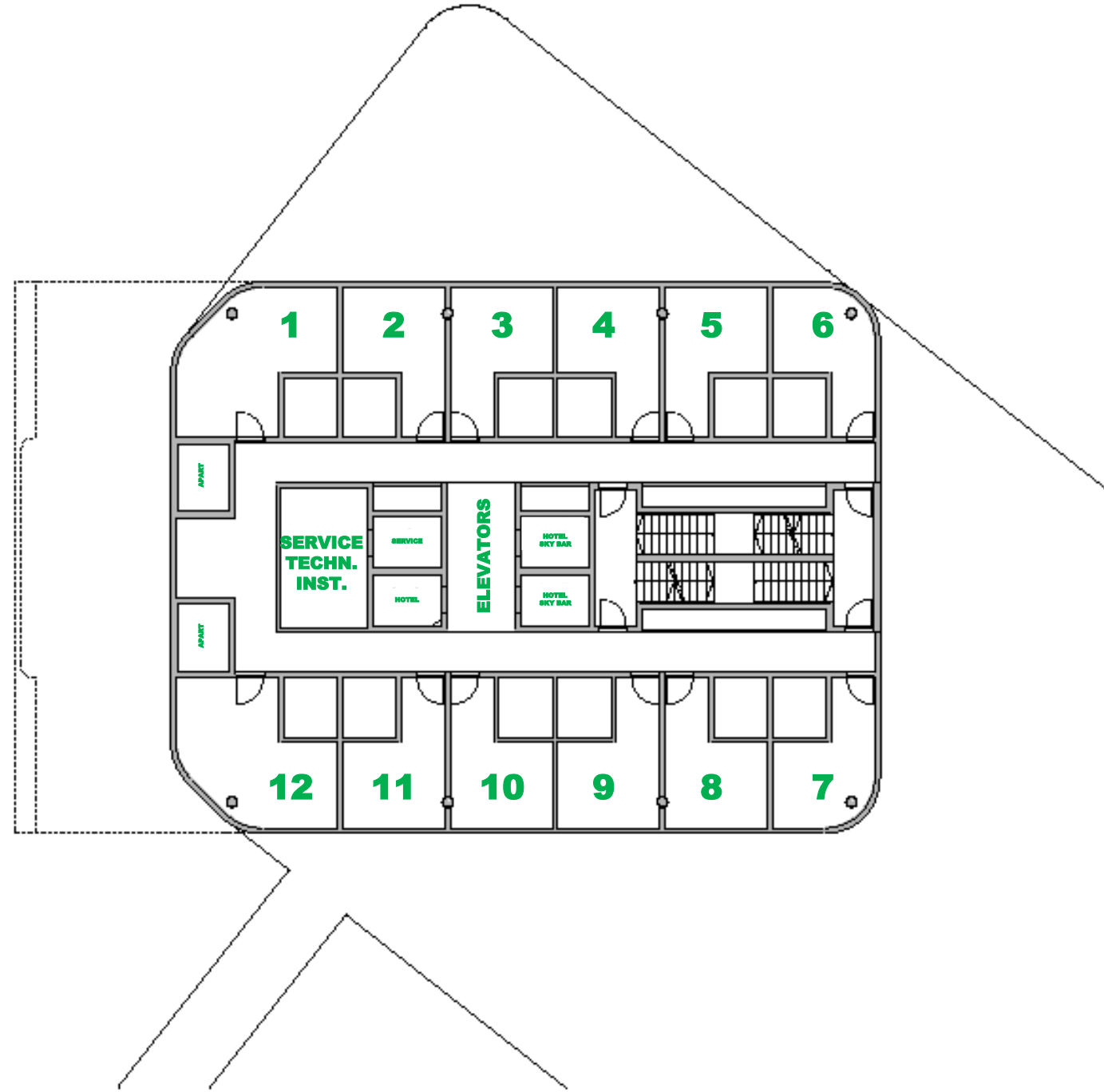

technical floor  
with service  
area

bta new:560m<sup>2</sup>

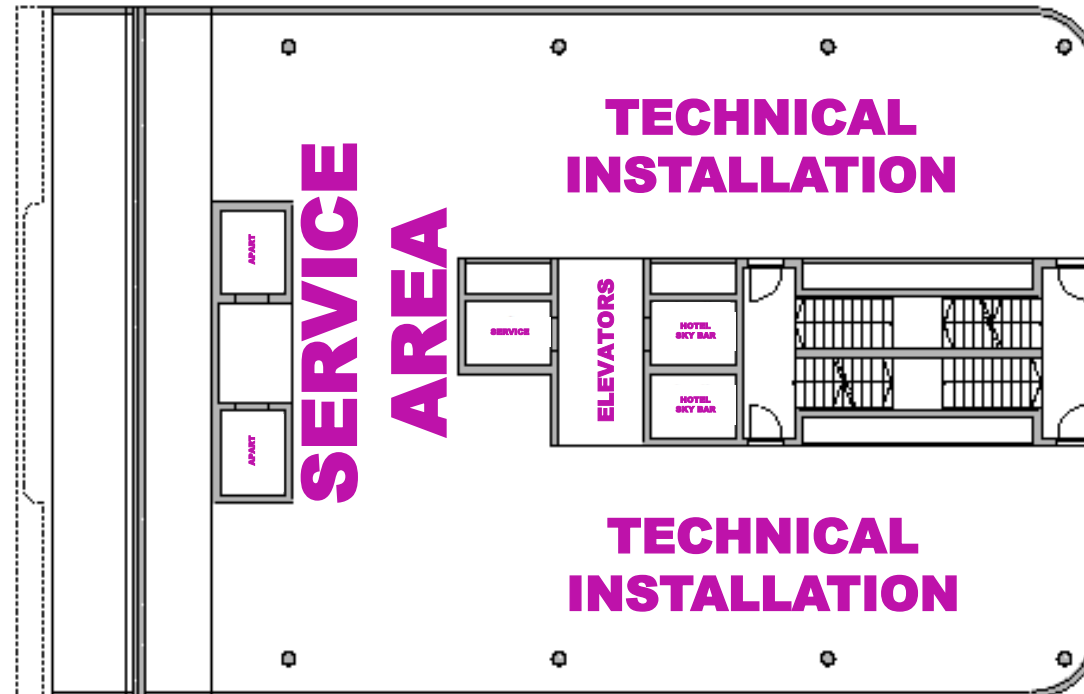



6 floors with  
each 4  
apartments

bta new:  
6 x 645m<sup>2</sup>

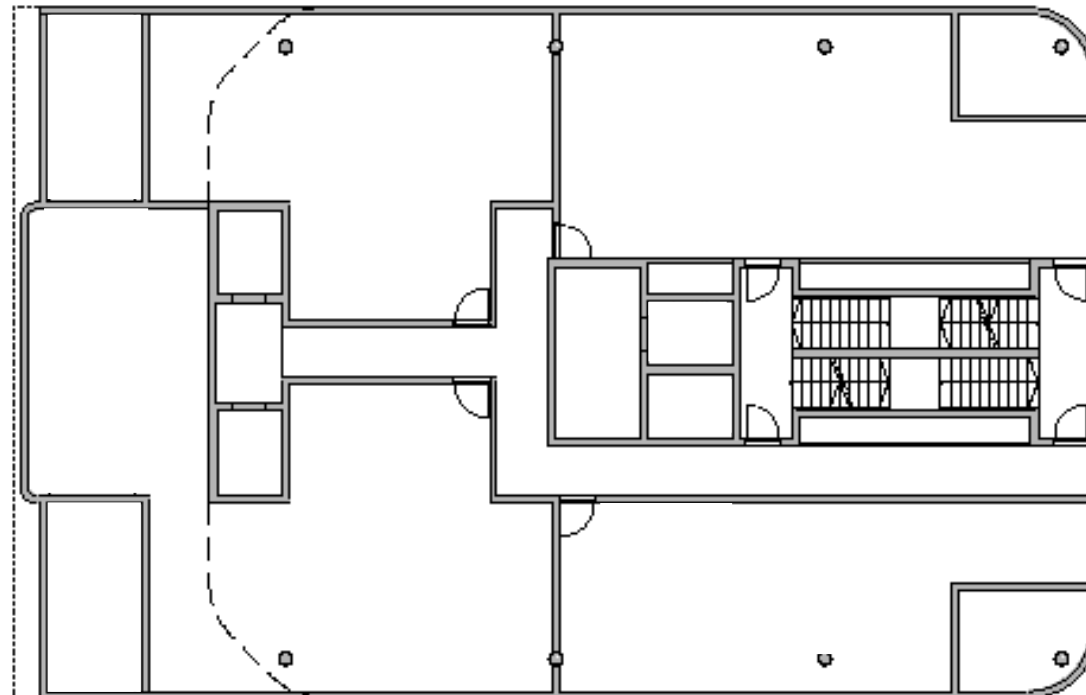

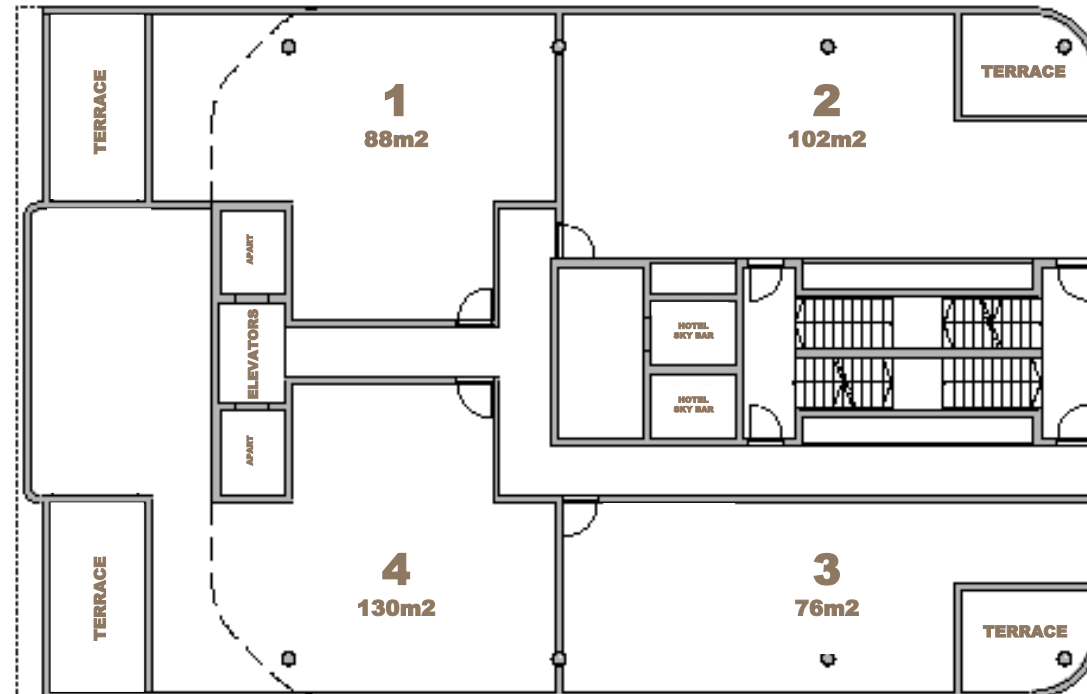

sky bar and  
conference  
rooms

bta new:660m<sup>2</sup>



360° viewing  
platform

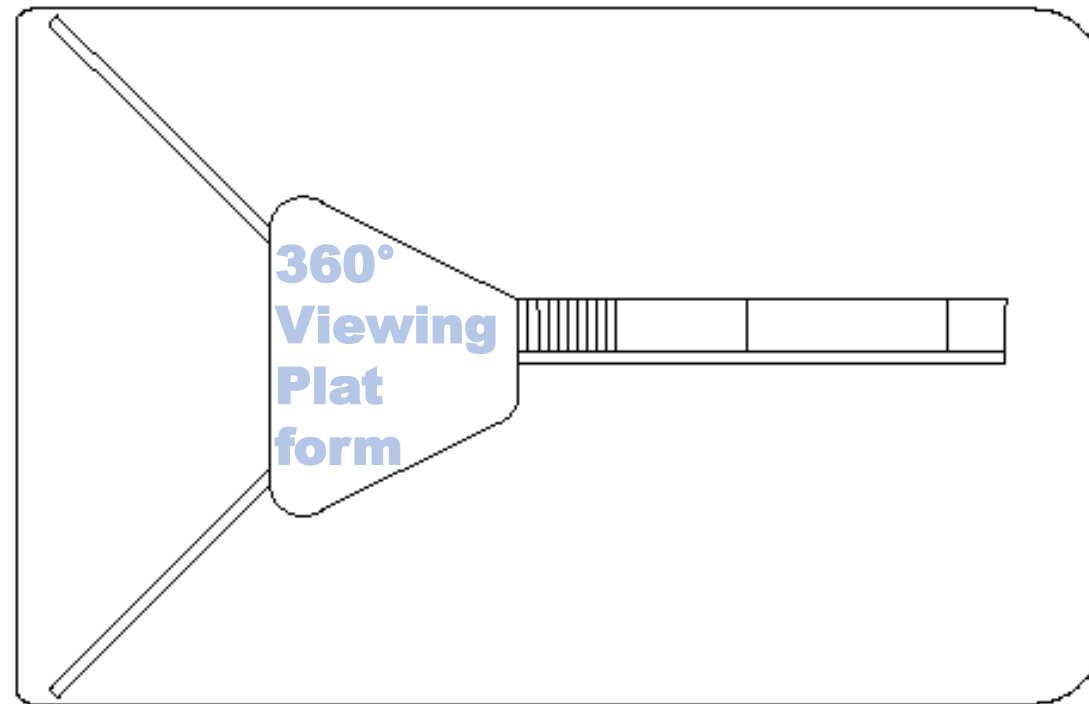



**360° VIEWING PLATFORM**

**SKY BAR / CONFERENCE ROOMS**

**APARTMENTS**

**TECHNICHNICAL INSTALLATION**

**HOTEL ROOMS**

**BREAKFAST AND CONFERENCE ROOMS**

**LOBBY / RECEPTION AND STORES**

**PARKING**

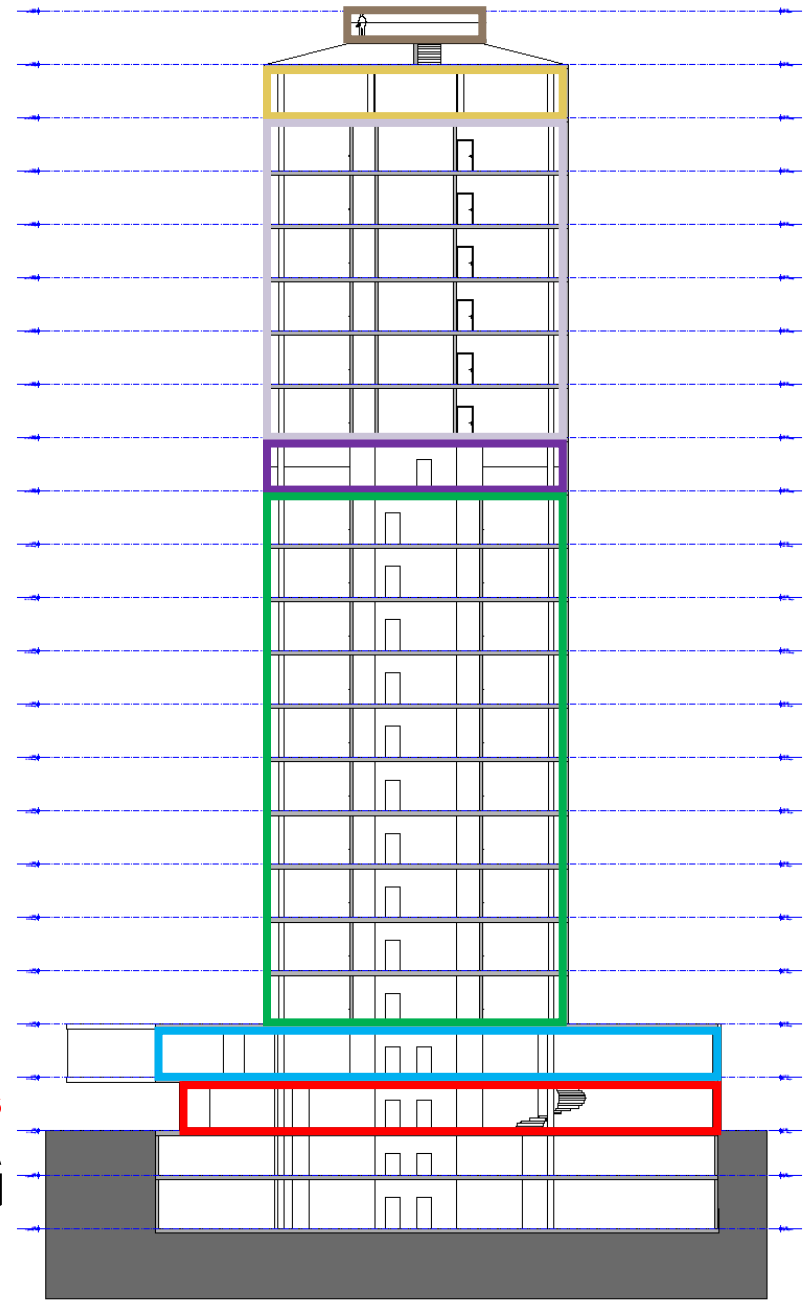

section

total bta including  
underground  
parking: 16140m<sup>2</sup>

View from  
Kirkegata



View from Thomas  
von Westens gate







CLARICO



